

Model#

C02001213F3A

2-way, Guided Pilot Diaphragm solenoid valve, Normally Closed

Technical Specifications

Pipe Size (Inch)	Orifice Size (Inch)	Flow Factor (CV)
1/2"	1/2"	4
Voltage	Power	Min. Pressure (PSI)
230VAC	17VA	0
		Max Pressure (AC)
		174
Temperature Range	Medium Examples	Sealing Material
5° - 320° F	Light Oils, Air, Water	FKM



Valve Dimensions

(F.F.):	1/2"
(DN):	1/2"
(L):	2 3/4"
(L1):	1 3/16"
(L2):	1 1/2"
(A):	1 3/4"
(B):	3 1/2"
(C):	4 1/16"
(D):	1 3/16"
(CH):	1 1/8"

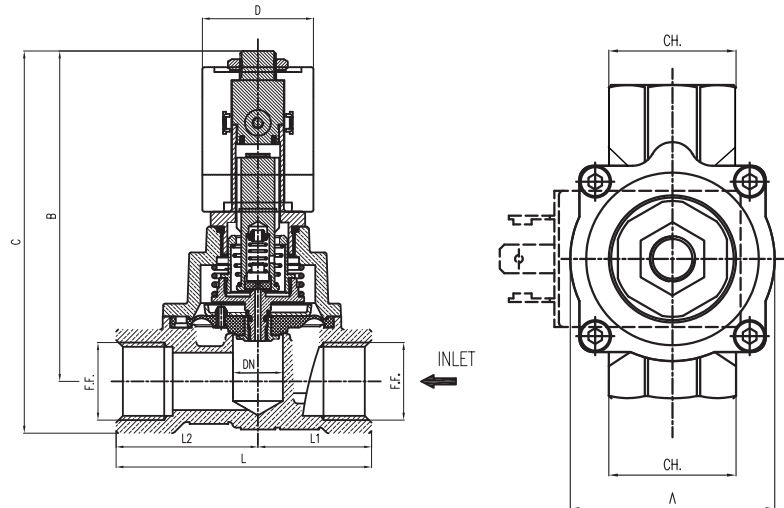

Electrical Connection

Rating:	NEMA 4/ IP 65
Strain Relief Connector:	Model 020

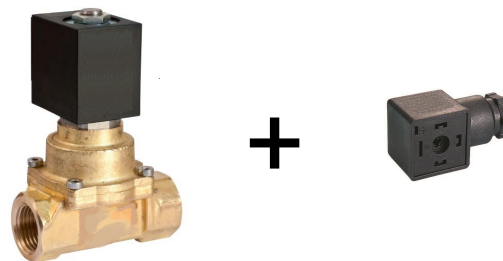

Note: Valve is pictured above with a sample coil, which may or may not reflect exact specifications of this particular build.