

Model# **C02010026N1D**

2-way, Guided Pilot Diaphragm solenoid valve, Normally Closed

Technical Specifications

Pipe Size (Inch)	Orifice Size (Inch)	Flow Factor (CV)	
1"	1"	10.9	
Voltage	Power	Min. Pressure (PSI)	Max Pressure (DC)
12VDC	19W	0	43.5
Temperature Range	Medium Examples	Sealing Material	
-4° - 194° F	Light Oils, Air, Water	NBR	



Valve Dimensions

(F.F.):	1"
(DN):	1"
(L):	3 11/16"
(L1):	1 11/16"
(L2):	1 15/16"
(A):	2 13/16"
(B):	3 7/8"
(C):	4 11/16"
(D):	1 3/16"
(CH):	1 5/8"

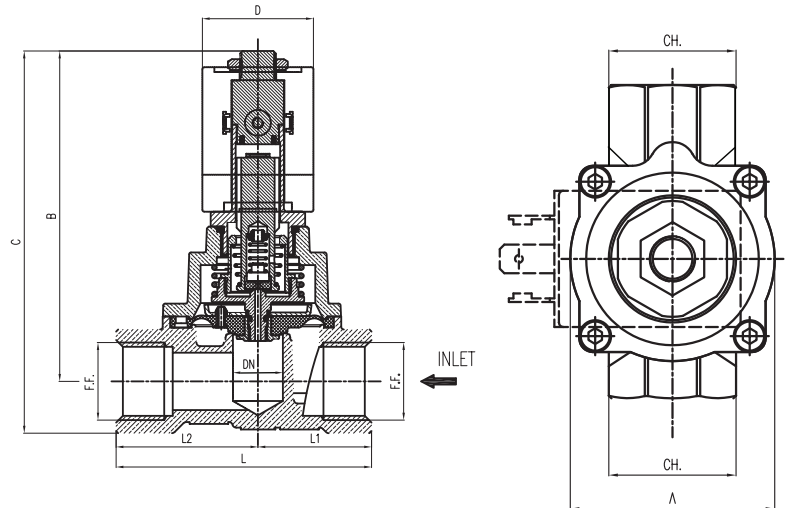

Electrical Connection

Rating:	NEMA 4/ IP 65
Strain Relief Connector:	Model 020

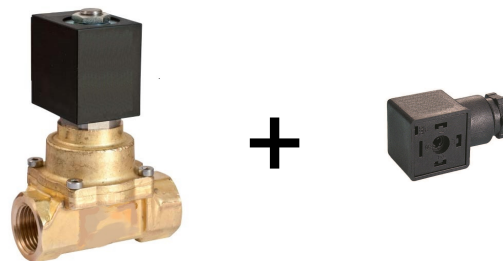

Note: Valve is pictured above with a sample coil, which may or may not reflect exact specifications of this particular build.