

Model#

C02003811F2D

2-way, Guided Pilot Diaphragm solenoid valve, Normally Closed

Technical Specifications

Pipe Size (Inch)	Orifice Size (Inch)	Flow Factor (CV)
3/8"	7/16"	3
Voltage	Power	Min. Pressure (PSI)
24VDC	19W	0
		Max Pressure (DC)
		72.5
Temperature Range	Medium Examples	Sealing Material
5° - 320° F	Light Oils, Air, Water	FKM



Valve Dimensions

(F.F.):	3/8"
(DN):	7/16"
(L):	2 1/2"
(L1):	1 1/8"
(L2):	1 7/16"
(A):	1 3/4"
(B):	3 1/2"
(C):	4 1/16"
(D):	1 3/16"
(CH):	1 1/8"

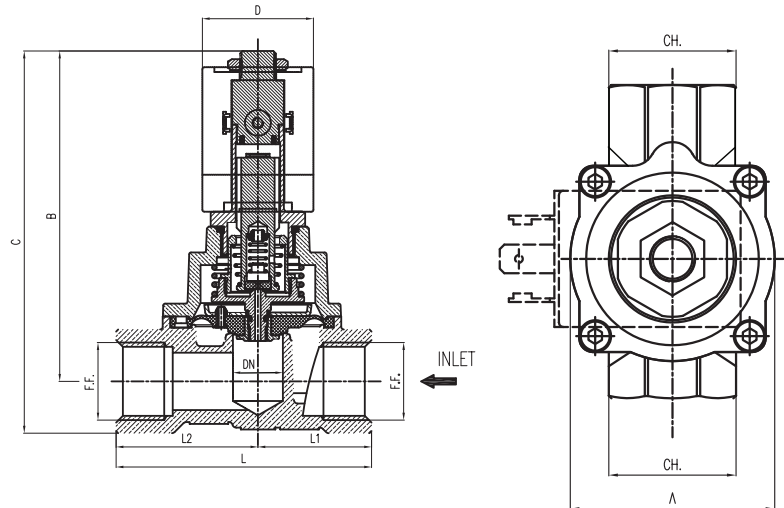

Electrical Connection

Rating:	NEMA 4/ IP 65
Strain Relief Connector:	Model 020

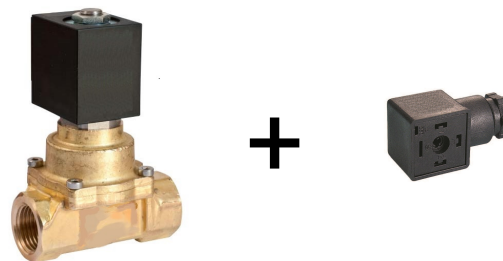

Note: Valve is pictured above with a sample coil, which may or may not reflect exact specifications of this particular build.