

Model#

C02003418F2A

2-way, Guided Pilot Diaphragm solenoid valve, Normally Closed

Technical Specifications

Pipe Size (Inch)	Orifice Size (Inch)	Flow Factor (CV)	
3/4"	11/16"	6.7	
Voltage	Power	Min. Pressure (PSI)	Max Pressure (AC)
24VAC	17VA	0	116
Temperature Range	Medium Examples	Sealing Material	
5° - 320° F	Light Oils, Air, Water	FKM	



Valve Dimensions

(F.F):	3/4"
(DN):	11/16"
(L):	3 11/16"
(L1):	1 11/16"
(L2):	1 15/16"
(A):	2 13/16"
(B):	3 7/8"
(C):	4 11/16"
(D):	1 3/16"
(CH):	1 5/8"

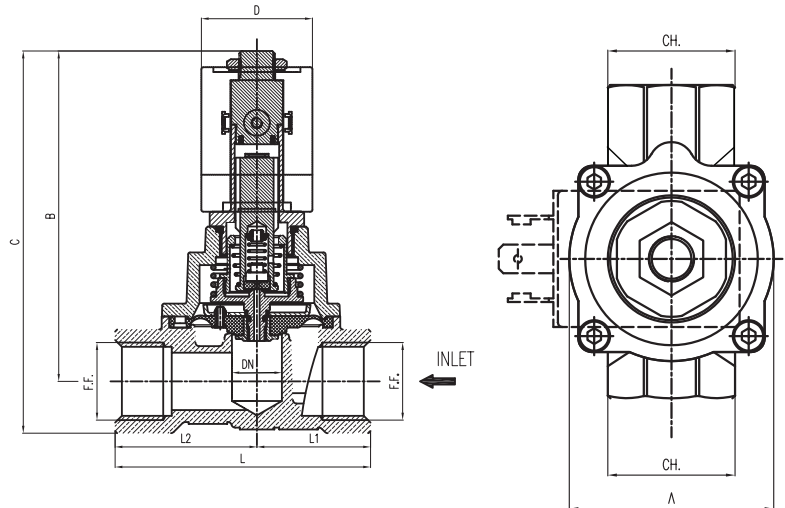

Electrical Connection

Rating:	NEMA 4/ IP 65
Strain Relief Connector:	Model 020

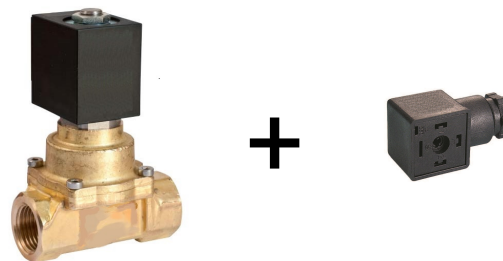

Note: Valve is pictured above with a sample coil, which may or may not reflect exact specifications of this particular build.